

57636 11/06 - (BJ)

Introduction

The thermostat is capable of switching on your heating system at pre determined times on different days of the week. It is possible to set 4 periods called events each day with different temperatures. From the factory, a default schedule is programmed suitable for most installations. Unless you change these settings the thermostat will operate to this default program.

Working with lower temperatures during times that the room is unoccupied could lower your energy costs without reducing the comfort. The thermostat has an adaptive function that automatically changes the start time of a heating period so that the desired temperature is reached at the time that you set. After 5 days the adaptive function has learned when the heating must be switched on.

The thermostat has a pin button marked R, allowing you to reset the thermostat to factory settings. These are listed at the end of this manual with space for you to record your own weekly schedule.

The display is backlit when operating the buttons. The heating element is switched off when the light is on in the display.

The heating system can be switched off on the built-in interrupter. The Microprocessor taking care of the time will still be supplied with power whereby time and day will be maintained. When the heating is required and the thermostat is switched on, it will continue the 4-event programme based on present time and day.

1. Getting started

Buttons

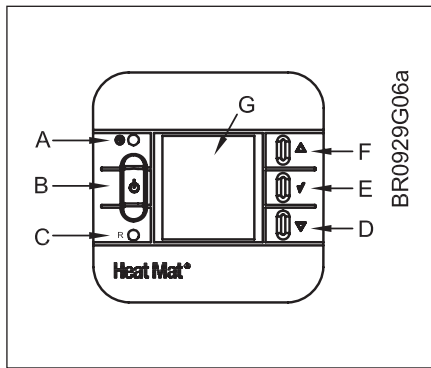

Display symbols

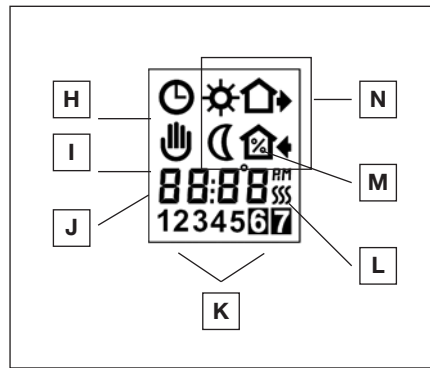

A:	B:	C:	D:
Pin button adjust of clock	On/off	Reset to factory setting	Adjustment down

H:	I:	J:	K:
Clock function	Manual mode	Time and temperature	Day number

E:	F:	G:
OK - accept	Adjustment up	Display

L:	M:	N:
Heating on	% Monitoring of switch-on time	4-event symbol Wake Out Night Home

Setting the thermostat into operation

First time power is connected the clock and day will be flashing and must be set. If you need to adjust the time of the thermostat at a later date, insert a pin into the hole for setting of time and day and press for 3 seconds. Adjustment must be made for summer and winter time.

		Press the UP () or DOWN () buttons to select the correct time and press OK button () .	
		Then press the UP () or DOWN () button to select the correct day and press OK () button.	1-7
		Then press the UP () or DOWN () button to select the requested temperature in manual mode and press OK () button.	°C









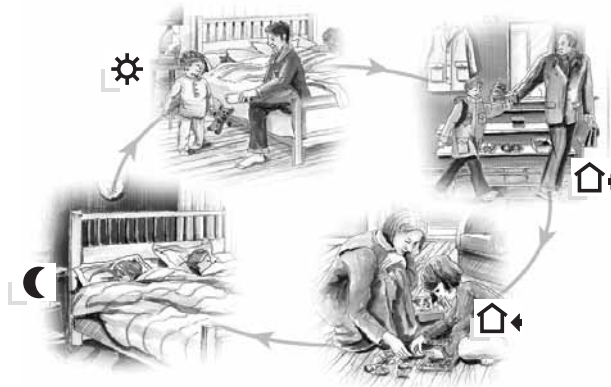

- To activate the 4 event clock mode press the OK () button once.
- The temperature set in room temp - This can be changed to floor sensor only if the programmer is outside the room, in a cupboard or in a warm room. See: 4. Advanced Optional Settings, APP

2. Daily use of the thermostat

4-event clock mode

The day has been split into 4 events describing a typical day. When the thermostat is in 4-event mode it will automatically adjust the temperature according to the required temperature to the required time. These settings are valid for the weekdays 1-7 (Monday to Sunday), which are shown on the display. Depending on the program chosen, the settings can be made for one single day or identical settings for all 7 days..



4-event clock mode: 		The clock function symbol (⌚) and one of the 4-event symbols (⚙️ 🏠➡️ 🏠➡️🌙) will be indicated. Programming see 3.
Comfort mode: 		Temporary override To temporarily override the temperature in the 4-event schedule program, press the UP (⬆️) or DOWN (⬇️) button once, to show the temperature, and press again to increase or decrease the temperature. Press the OK (✓) button. The override will operate until the next programmed event when the unit will resume the automatic programme.
		Cancel comfort mode To cancel the override state, press the OK (✓) button twice.
Manual mode: 		Permanent override: During holidays, the scheduled 4-event program can be overridden. Press the OK (✓) button, and then the UP (⬆️) or DOWN (⬇️) button until the override temperature is set. The unit will now operate to this temperature permanently. Press the OK (✓) button.
		Cancel manual mode To cancel the permanent override state press the OK (✓) button once, and the unit will resume automatic function.

3. Programming

4-event time and temperature

For each event, the start time and required temperature must be set.

For example, in the morning you wish the heating to start at 07:00 and the temperature to rise to 25°C. Press OK (✓) button for 3 seconds and the start time is displayed. Change this to 07:00 with the UP (⬆️) or DOWN (⬇️) button. Press OK (✓) to confirm. The temperature is now displayed. Change this to 25°C with the UP (⬆️) or DOWN (⬇️) button. Press OK (✓) button to confirm. This action can now be repeated for the second event.









These settings are valid for the weekdays 1-7 (Monday to Sunday), which are shown on the display. Depending on the program chosen, the settings can be made for one single day or common settings for all 7 days.

The temperature can be set within the range of +5 to +27°C * when first switched on.

* This can be increased up to a maximum of +45°C (under tiles only)

See : 4. Advanced Optional Settings, HiLi.





Your thermostat is now programmed to your desired settings. Should you wish to use any further options please read on.

Press OK (✓) button for 3 secs. to begin programming		
Day 1 - 7		
		⚙️ : Time and temperature
		🏠➡️ : Time and temperature
		🏠➡️ : Time and temperature
		🌙 : Time and temperature
If program 7:0 has been chosen it is possible to program the 4 event settings individually for each day of the week.		

4. Advanced Optional Settings (Only use if directed in previous sections)

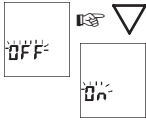
	<p>Press both UP (Δ) and DOWN (∇) buttons together for 3 seconds. INFO is displayed. Press UP (Δ) button until you reach the desired sub menu. Select the sub menu with the OK (✓) button.</p>
	<p>Monitoring of energy consumption The thermostat calculates average time it has been switched on allowing you to monitor your energy consumption. In the thermostat you can read out: Total switch-on time in percentage in the latest 2 days, 30 days or 365 days. Calculation of operational costs per day: (switch-on time:100) x kW x kWh-price x 24 h per day Example: Read-out: 30 % in the latest 365 days Size of heating system: 1.2 kW (ask the installer) Cost of power: 5 p/ kWh Calculation: (30:100) x 1.2 kW x 5 p / kWh x 24 h = 0.4 £ per day</p>
<p>2 days 30 days 365 days Software version Regulation sensor Limit sensor (if used) Function selection</p>	<p>Press UP (Δ) or DOWN (∇) button to show the different readouts. No changes can be made here. Use the OK (✓) button to end.</p>
	<p>4-event sequence The actual sequence is blinking: Day 1-7 (7:7). To change the selection press the UP button until day 1-7 is blinking individually (7:0). Select the wanted program by clicking OK.</p>
	<p>7:7 4-events which are common for all 7 days 7:0 4-events for each of the 7 days</p>
	<p>Selection of type. As standard the thermostat controls the temperature within the room and use the externally temperature sensor as limit sensor avoiding to high or to low temperatures in the floor, select (roLi). If you only want the thermostat to control the floor temperature select (FLo). In this case the room temperature is not controlled. When changing to control after a floor temperature the temperature will be increased with 5°C. Example if controlling after a room temperature of 20°C setting ro + roLi it will control after 25°C when set for Flo.</p>
	<p>roLi Room temperature control with floor limitation sensor FLo Floor temperature control</p>
	<p>Max and min allowed temperature of the floor surface Max limitation is used for safety to prevent high floor temperatures. For example wooden floor constructions which should not be allowed to exceed a maximum of 27°C. The value can be set from 5°C up to 55°C. Low limitation is used where the temperature of the floor is required never to fall below the minimum set temperature. Example in kitchens or bathrooms with tiles. The value can be set from 5°C up to 30°C. Remember the max limit temperature must be set higher than the min limit temperature.</p>
	<p>Maximum allowed temperature setting. Use the UP (Δ) or DOWN (∇) button to increase or reduce, and OK (✓) button to accept. Next is displayed LoLi. Press OK (✓) button to continue. Minimum allowed temperature setting. Use the UP (Δ) or DOWN (∇) button to increase or reduce and OK (✓) button to accept.</p>

4. Continued

	<p>Adaptive function: This function enables the thermostat to calculate when it needs to switch ON so that the required temperature is reached at the set time. With a start time of 07:00 therefore, the thermostat may switch ON as early as 06:00 so that the desired temperature of 25°C is achieved by 07:00. Without this function set, the thermostat will start to heat at the time you set.</p>	
		<p>Press the DOWN (▽) button to switch between on and off. Press OK (✓) button to confirm.</p>
	<p>Offset. A correction of the control temperature can be made assuring influences from the installation are eliminated. The correction can be set from -5°C to +5°C.</p>	
		
		<p>Press OK (✓) button to end programming and to return to scheduled programme.</p>

5. Reset to factory setting

	<p>Press the pin button in 3 seconds and the thermostat returns to factory settings. Time and day is also reset and must be set according to "Setting the thermostat into operation".</p>
---	---

Factory settings

4-event time and temperature			
Day 7-0	Time		Temperature
☀	06:00		20°C
🏠➡	08:00		5°C
🏠➡	16:00		22°C
🌙	21:30		5°C
Limit sensor temp.			27°C/5°C
4-event sequence	7:7		
Scale	24 H / °C		
Adaptive control	OFF		

6. Failure codes

- E0 = Internal failure, replace thermostat
- E1 = Built-in sensor short-circuit or disconnected, replace thermostat
- E2 = External sensor short-circuit or disconnected

Heat Mat Limited

8, Ashwyn Business Centre
Marchants Way, Burgess Hill
West Sussex RH15 8QY
Tel: 01444 247020
Fax: 01444 247121

